

FACTORY "L" TRANSITION

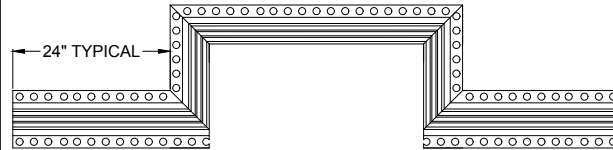

FACTORY "COLUMN" TRANSITION
(SEE 30101-01c FAB SHEET)

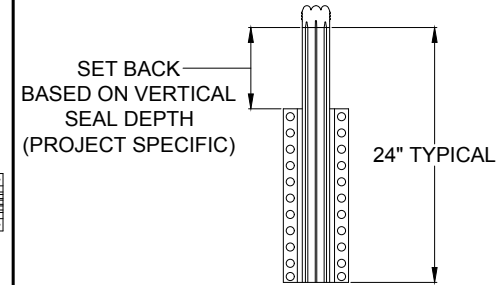

FACTORY "6" TURN-UP RECESSED" TRANSITION
(TO ACCOMMODATE VERTICAL EXPANSION JOINT)
SEE DRAWING 30101-01b

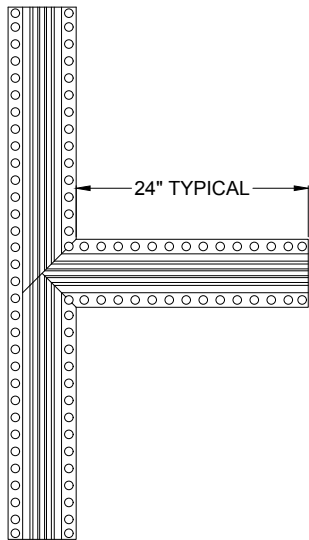

FACTORY "TEE" TRANSITION

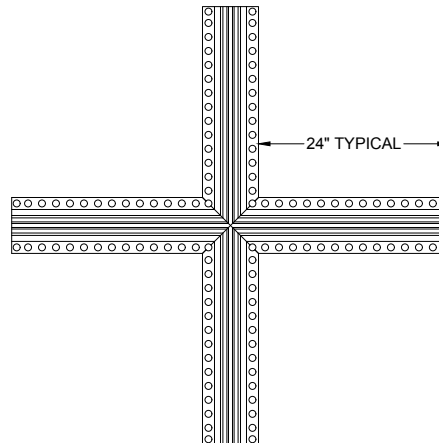

FACTORY "CROSS" TRANSITION

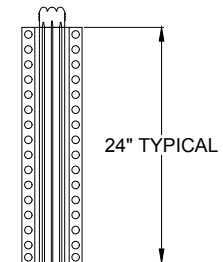

FACTORY "6" TURN-UP FLUSH" TRANSITION
(FLUSH WITH FACE OF COLUMN OR WALL)
SEE DRAWING 30101-01b



50 MM WAY
PENDERGRASS, GA. 30567
706-824-7500 PHONE
800-241-3460 TOLL FREE
706-824-7501 FAX

www.mm-usa.com

For Spec-Data, Install Guides and other data visit www.mm-usa.com.

RIGHTS OF DESIGN

All rights of design, detail, engineering and/or invention contained herein are the property of MM Systems Corporation and hereby reserved and are not to be reproduced or provided to any other party. MM Systems Corporation reserves the right to amend or withdraw any information contained herein without notice and will not be liable for any inaccuracy or ambiguity of said information.

**LokCrete Membrane System Expansion Joint
LMS Factory Directional Transitions**

Drawn by: DMW	Scale: NTS	Drawing Number:
SHT. 1 OF 4	Issue Date: 12-28-2017	30101-01a

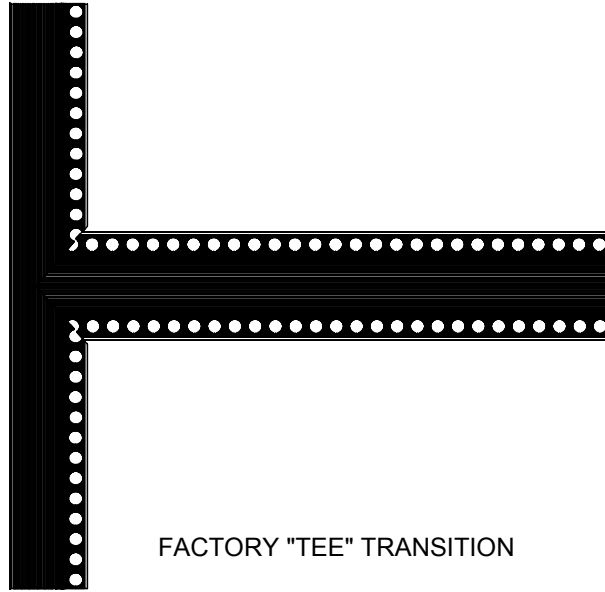

FACTORY "TEE" TRANSITION

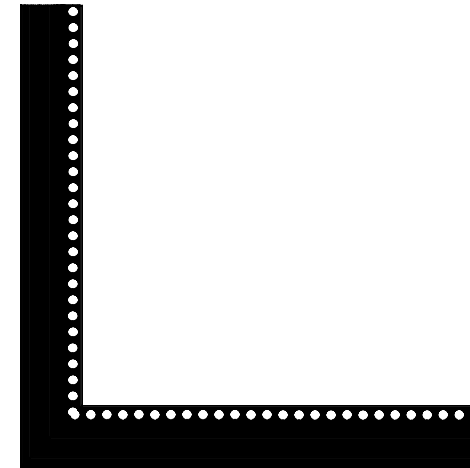

FACTORY "L" TRANSITION

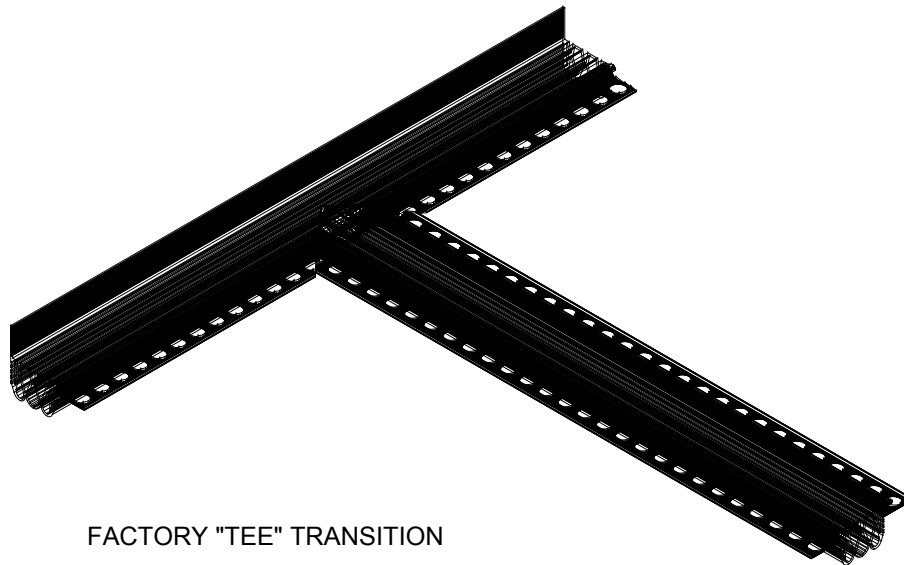

FACTORY "TEE" TRANSITION

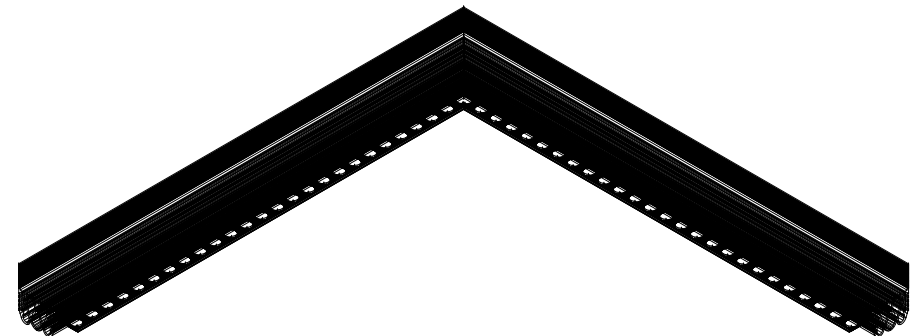

FACTORY "L" TRANSITION



50 MM WAY
 PENDERGRASS, GA. 30567
 706-824-7500 PHONE
 800-241-3460 TOLL FREE
 706-824-7501 FAX

www.mm-usa.com

For Spec-Data, Install Guides and other data visit www.mm-usa.com.

RIGHTS OF DESIGN

All rights of design, detail, engineering and/or invention contained herein are the property of MM Systems Corporation and hereby reserved and are not to be reproduced or provided to any other party. MM Systems Corporation reserves the right to amend or withdraw any information contained herein without notice and will not be liable for any inaccuracy or ambiguity of said information.

**LokCrete Membrane System Expansion Joint
 LMS Factory Directional Transitions**

Drawn by: DMW	Scale: NTS	Drawing Number: 30101-01a
SHT. 2 OF 4	Issue Date: 12-28-2017	

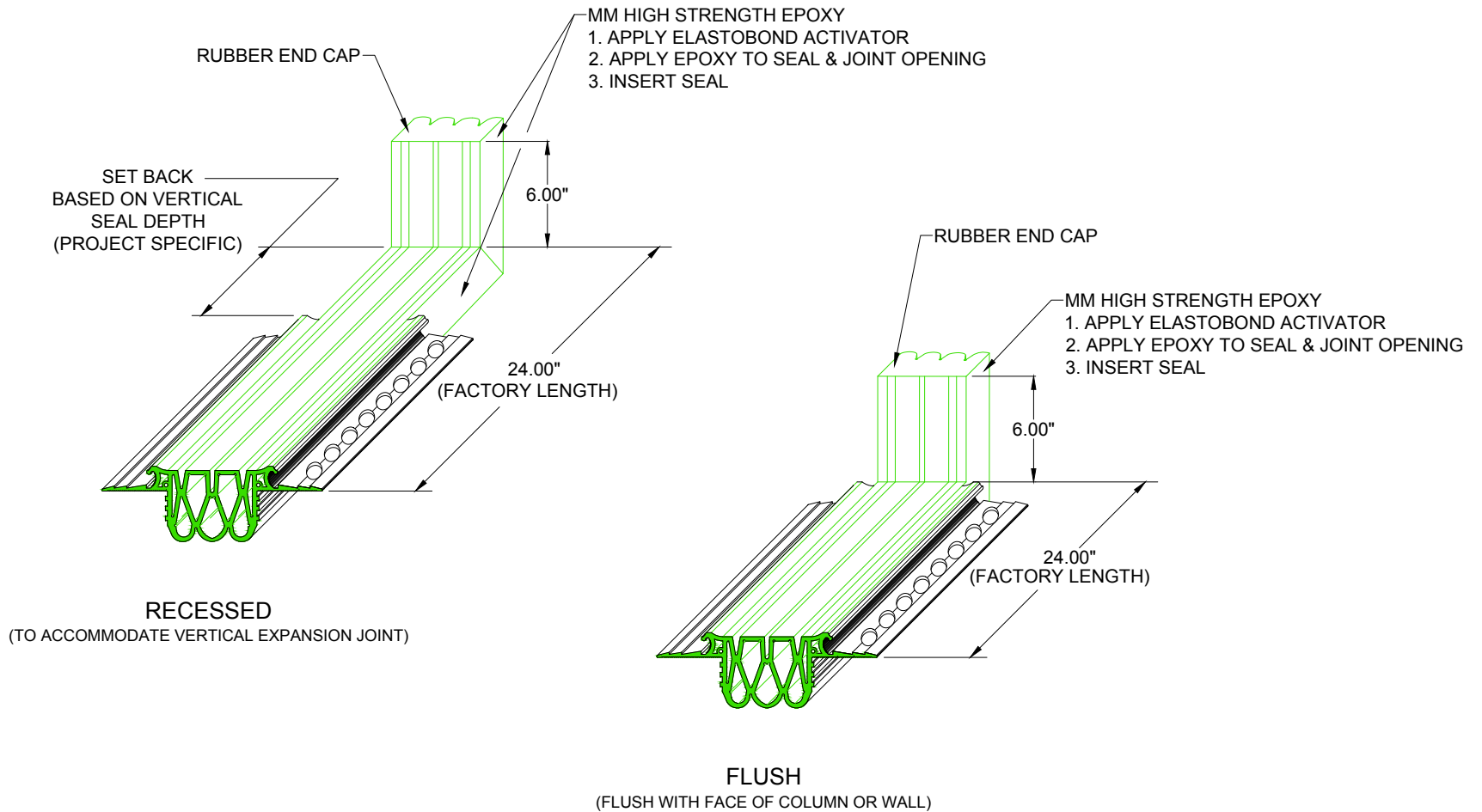

NOTE: TRANSITIONS CAN BE FACTORY PRE-FABRICATED OR FIELD FABRICATED



50 MM WAY
PENDERGRASS, GA. 30567
706-824-7500 PHONE
800-241-3460 TOLL FREE
706-824-7501 FAX

www.mm-usa.com

For Spec-Data, Install Guides and other data visit www.mm-usa.com.

RIGHTS OF DESIGN

All rights of design, detail, engineering and/or invention contained herein are the property of MM Systems Corporation and hereby reserved and are not to be reproduced or provided to any other party. MM Systems Corporation reserves the right to amend or withdraw any information contained herein without notice and will not be liable for any inaccuracy or ambiguity of said information.

LokCrete Membrane System Expansion Joint
LMS 6 inch Factory Turn-up Transitions

Drawn by: DMW	Scale: NTS	Drawing Number: 30101-01c
SHT. 3 OF 4	Issue Date: 12-28-2017	

"A" DIMENSION _____
 "B" DIMENSION _____
 "C" DIMENSION _____

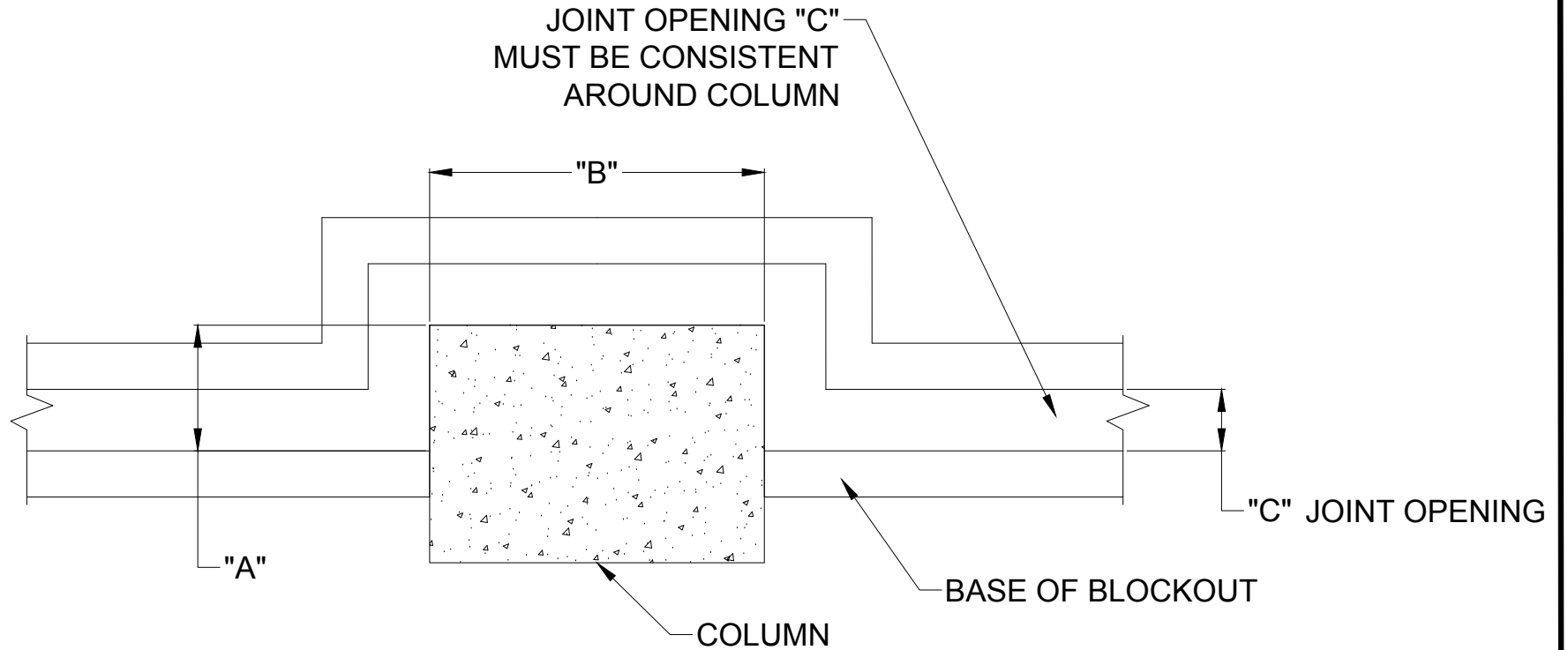

FIELD DIMENSION VERIFICATION FAB SHEET



50 MM WAY
 PENDERGRASS, GA. 30567
 706-824-7500 PHONE
 800-241-3460 TOLL FREE
 706-824-7501 FAX

www.mm-usa.com

For Spec-Data, Install Guides and other data visit www.mm-usa.com.

RIGHTS OF DESIGN

All rights of design, detail, engineering and/or invention contained herein are the property of MM Systems Corporation and hereby reserved and are not to be reproduced or provided to any other party. MM Systems Corporation reserves the right to amend or withdraw any information contained herein without notice and will not be liable for any inaccuracy or ambiguity of said information.

LokCrete Membrane System Expansion Joint LMS Column Dimension Fab Sheet

Drawn by: DMW	Scale: NTS	Drawing Number: 30101-01d
SHT. 4 OF 4	Issue Date: 12-28-2017	