

DIH-C-300 Expansion Joint
(Floor-to-Wall / 1" Corner)

SEE DRAWING 30950-04 SHEET 2 OF 2 FOR 0.50" LEG HEIGHT



50 MM WAY
PENDERGRASS, GA. 30567
706-824-7500 PHONE
866-506-6929 TOLL FREE
706-824-7501 FAX

www.mm-usa.com

For Spec-Data, Install Guides, and other data visit www.mm-usa.com.

RIGHTS OF DESIGN

All rights of design, detail, engineering and/or invention contained herein are the property of MM Systems Corporation and hereby reserved and are not to be reproduced or provided to any other party. MM Systems Corporation reserves the right to amend or withdraw any information contained herein without notice and will not be liable for any inaccuracy or ambiguity of said information.

Dual Interlocking Hinge Expansion Joint
DIH-C-300 Series 1.00" Wall Mount

Drawn by: DMW	Scale: NTS	Drawing Number: 30950-06
Sheet 1 of 2	Issue Date: 01-29-2019	

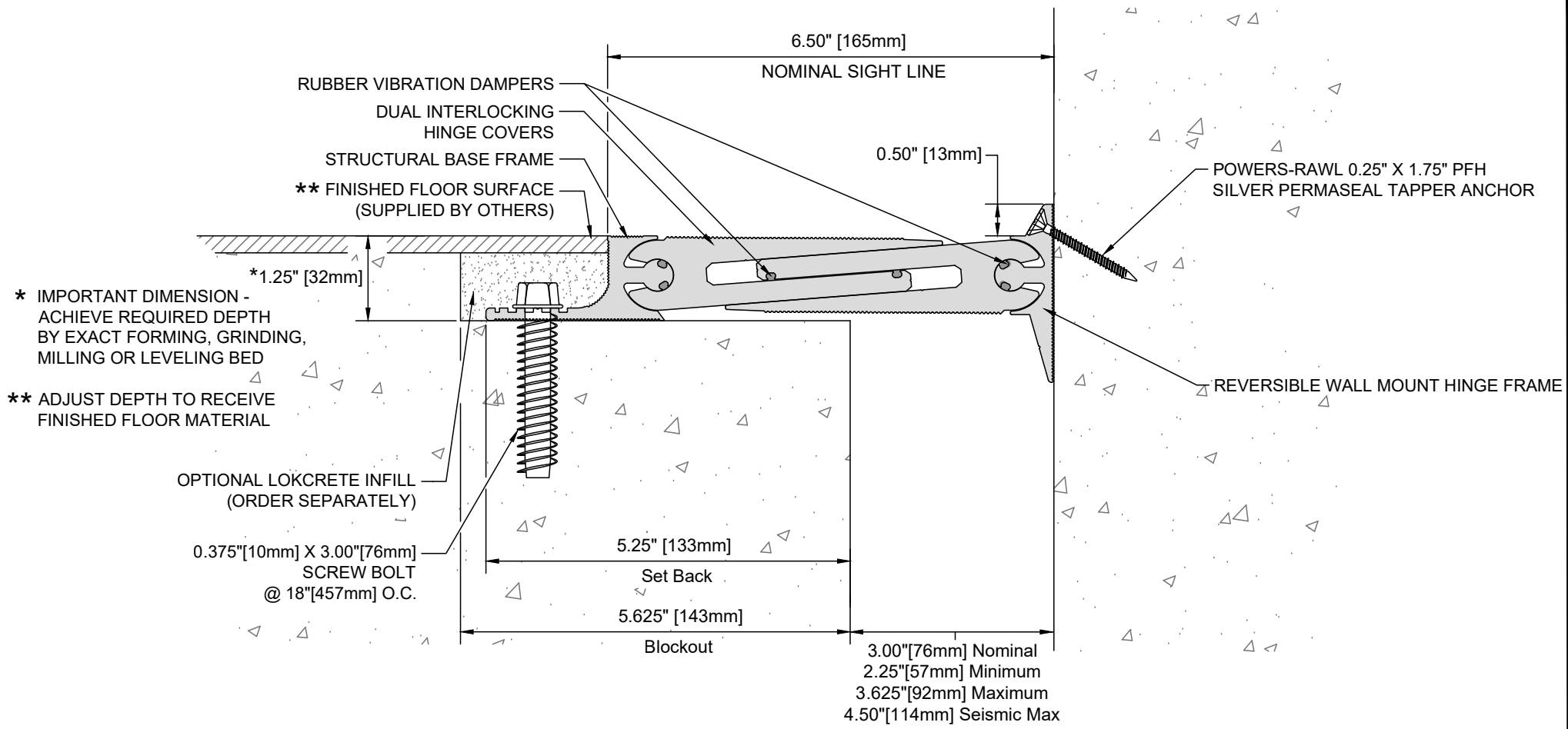

DIH-C-300 Expansion Joint
(Floor-to-Wall / 0.50" Corner)

SEE DRAWING 30950-04 SHEET 1 OF 2 FOR 1.00" LEG HEIGHT



50 MM WAY
PENDERGRASS, GA. 30567
706-824-7500 PHONE
866-506-6929 TOLL FREE
706-824-7501 FAX

www.mm-usa.com

For Spec-Data, Install Guides, and other data visit www.mm-usa.com.

RIGHTS OF DESIGN

All rights of design, detail, engineering and/or invention contained herein are the property of MM Systems Corporation and hereby reserved and are not to be reproduced or provided to any other party. MM Systems Corporation reserves the right to amend or withdraw any information contained herein without notice and will not be liable for any inaccuracy or ambiguity of said information.

Dual Interlocking Hinge Expansion Joint
DIH-C-300 Series 0.50" Wall Mount

Drawn by: DMW	Scale: NTS	Drawing Number: 30950-06
Sheet 2 of 2	Issue Date: 01-29-2019	